

 HUANANZHI®



HUANANZHI®

SZ HUANAN SANXIAN TECHNOLOGY CO.,LTD.

WWW.HUANANZHI.COM



X99-F8D PLUS
V1.2 说明书

目录

安全信息	2
包装说明	3
简介	4
主板图解	5
后置I/O面板	6
安装与设置	7
驱动程序的安装	11
BIOS设置	13

安全信息

- 此包装中包含的组件有可能静电放电 (ESD) 损坏。请遵守以下注意事项, 以确保成功组装计算机
- 确保所有组件连接牢固。若连接不紧可能会导致计算机无法识别组件或无法开启
- 拿取主板时为防止静电损坏其配置, 请在拿取主板前通过接触其它金属物体释放自身的静电
- 拿起主板时请手持主板边缘, 避免触及主板的敏感组件
- 在不安装主板时, 请将主板放在静电屏蔽容器或防静电垫上
- 在打开计算机前, 确保计算机机箱内的主板或任何位置上没有松动的螺丝或金属组件
- 在安装完成之前不要启动计算机。否则可能会导致组件永久性损坏以及伤害使用者
- 在任何安装步骤中, 如果您需要帮助, 请咨询专业的售后客服人员
- 安装或拆卸计算机任何组件之前, 请先关闭电源, 并将电源线由插座上拔除
- 本主板须远离湿气
- 保留本用户指南以供将来参考

- 在电源供应器连接到电源插座之前,请确保您的插座提供了电源供应器上额定相同的指示电压
- 将电源线摆放在在不会被人踩到的地方,不要在电源线上放置任何物品
- 发生下列任一状况时,请将本主板交由维修人员检查:
 - 有液体渗透至计算机内
 - 主板暴露于水气当中
 - 主板不工作,或您依照使用指南后仍无法让本主板工作
 - 主板曾掉落且损坏
 - 主板有明显的破损痕迹

包装说明

- 请确认您所购买的主板包装是否完整,如果有包装损坏或是任何配件损坏、短缺的情况,请尽快联系我们
 - 1.华南金牌X99-F8D PLUS V1.2主板一片
 - 2.SATA数据线 2根
 - 3.I/O后挡板一块
 - 4.保修卡一张

简介

特点介绍

CPU: 英特尔® LGA2011-3处理器 英特尔® 至强™
RAM: 8*DIMM 最大支持256GB DDR4
2400/2133/1866MHZ 非ECC.ECC内存
四通道存储器体系结构
实际内存数据速率取决于CPU类型和DRAM模块
I/O特效: 6 x SATA3.0(最大传输速度高达6GB/s)
4 x SSATA3.0
4 x USB2.0接口
4 x USB3.0接口
2 x RTL8125BG 网卡接口

音 频: Realtek 音讯转码器
ALC897 7.1环绕声高清晰度音频编解码器
音源输出: 前置输出/前置喇叭输出, 后置喇叭输出,
中置/重低音喇叭输出, 侧置喇叭输出
音源输入: 麦克风输入, 音频输入
以 太 网: 2 x RTL8125BG 2.5Gbps以太网
扩展插槽: 3 x PCIe 3.0 x16 3 x PCIe 3.0 x8
2 x M.2 22110 NVME PCIe 3.0X4
1 x M.2 2280 NVME PCIe 2.0 X4@NGFF SSATA3.0

主板图解



图1-1 X99-F8D PLUS V1.2主板图解

后置I/O面板

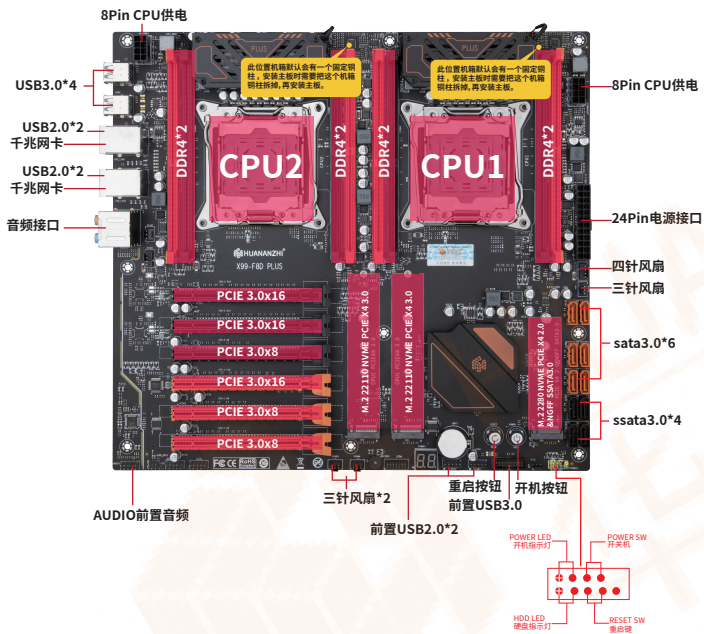

图1-2 整体后置I/O面板展示

连线/工作灯号		速度灯号
状态	描述	
关	网络未连接	关
黄色	网络已连接	绿色
闪烁	网络数据在使用中	橙色
		描述
		传输速率 10 Mbps
		传输速率 100 Mbps
		传输速率 1 Gbps

图1-3 LAN端口状态表

音频端口	通道			
	2	4	6	8
音频输入				
音频输出/前置喇叭输出	●	●	●	●
后置喇叭输出		●	●	●
中置/重低音输出			●	●
麦克风输入				●
侧置喇叭输出				

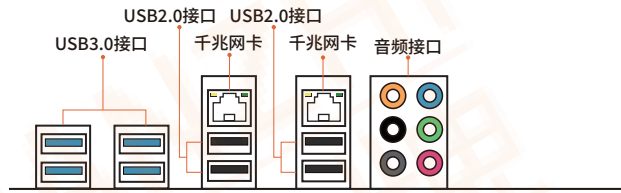
图1-4 音频端口配置

安装与设置

注意

请仔细查看主板，凡有表明“1”或是白色粗线标记的接脚均为1脚位置。



图2-1 清除CMOS跳线



1 MIC+ 麦克风插口	2 Ground 接地
3 Vbias麦克风电压	4 AuD_Vcc(AVCC) 声卡电源
5 L_R_Out 右声道输出	6 R_Out Back 右声道输出返回
7 N.C不连接	8 KEY 空脚
9 L_L_Out 左声道输出	10 L_Out Back 左声道输出返回

图2-2 前置音频输出

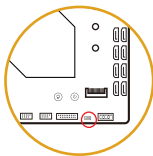
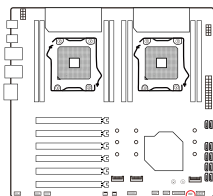
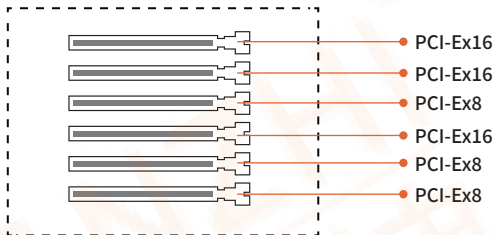
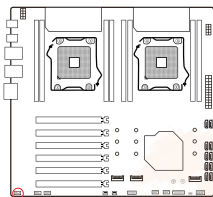
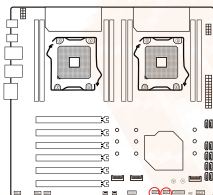

1 VCC 电源正极	2 VCC 电源负极
3 D- 数据负信号	4 D- 数据负信号
5 D+ 数据正信号	6 D+ 数据正信号
7 GND 接地	8 GND 接地
9 N.C 不连接	10 KEY 空脚

图2-3 USB扩充接口

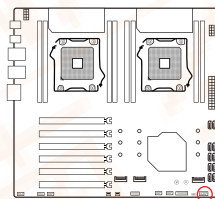

1 电源指示灯-电源正极	2 硬盘指示灯-电源正极
3 电源指示灯-电源负极	4 硬盘指示灯-电源负极
5 电源开关-电源开关	6 重新启动接口-重启开关
7 电源开关-电源开关	8 重新启动接口-重启开关
9 KEY空脚	10 N.C 空

图2-5 F_PANEL1开机接口

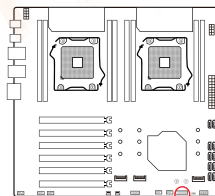

1 Power	2 USB3_RX_DN
3 USB3_RX_DP	4 Ground
5 USB3_TX_C_DN	6 USB3_TX_C_DP
7 Ground	8 USB2.0-
9 USB2.0+	10 GND
11 USB2.0+	12 USB2.0-
13 Ground	14 USB3_TX_C_DP
15 USB3_TX_C_DN	16 Ground
17 USB3_RX_DP	18 USB3_RX_DN
19 Power	20 N.C 空

图2-6 USB3.0接口

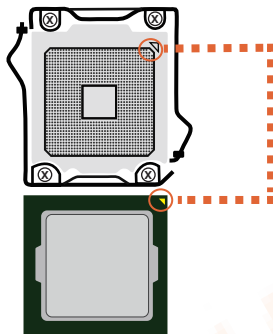
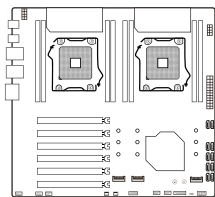

- 为了正确的将 CPU 放置在主板中, LGA2011-3CPU 的表面有两个对起点和一个金色三角指示。金色三角指示为 Pin1

图2-7 CPU安装



图2-8 M.2接口安装

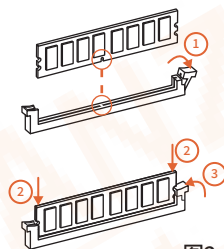

1. 将内存插槽两端的卡扣往外扳开, 内存条与插槽的凸出位置做对应, 确定安装的方向
2. 将内存条对准插槽, 按下去
3. 让插槽两端的卡扣自动弹起来

图2-9 内存安装



图2-10 显卡安装



图2 -11 SATA接口

驱动程序的安装

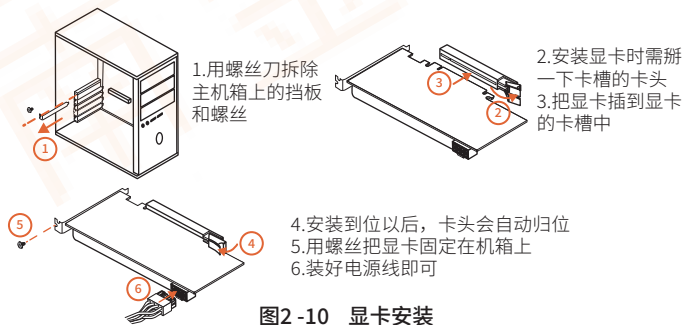
1.驱动程序目录一览：

驱动程序目录	驱动程序说明	适用操作系统
X99-F8D PLUS Chipset Driver	Intel 芯片信息安装	win7/win10/win11
X99-F8D PLUS Suond Card Driver	Realtek系列声卡驱动安装	win7/win10/win11
X99-F8D PLUSLAN Driver	瑞昱千兆网卡安装	win7/win10/win11

2.Intel 芯片信息安装

运行:控制面板—系统—硬件—设备管理器

“右击”改动驱动程序的硬件设备,继续下面安装

选择:属性—更新驱动程序—不连接到Internet—手动安装—找到对应的目录—选择“下一步”

3.声卡驱动程序安装

在进行此部分驱动程序安装之前,请您先找到您主板上的声卡芯片(可参考本手册主位标有声卡芯片位置)看看是何种型号,然后根据芯片型号选择对应的驱动程序进行安装

3.1 安装声卡驱动程序(以 HD Audio系列安装为例)

运行《驱动程序》:/X99-F8D PLUS SUOND CARD DRIVER/VISTA-WIN7-R897,XP

选择WDW-897

选择“下一步”继续

选择“完成”,系统将自动重启并完成安装

3.2 卸载声卡驱动程序(以HD Audio为例)

启动到 WINDOWS 桌面,选择“设置”/“控制”,再选择“添加 / 删除程序”;在“添加 / 删除程序”菜单中选择“Realte High Definition Audio Driver”点击“添加 / 删除”,驱动程序将自动移出。

4.外置显卡驱动程序安装

运行外置显卡《驱动程序》:目录下的 Setup.exe

点击“下一步”,继续

点击“是”,继续

点击“下一步”，继续

点击“下一步”，继续

点击“完成”，系统将会自动查找设备完成安装

5. 网卡驱动程序的安装

运行《驱动程序》: X99-F8D PLUS LAN DRIVER / WIN7 XP

点击“下一步”，继续

选择“安装”进行下面的安装

选择“完成”，重新启动计算机，系统将自动查找设备完成安装

BIOS设置

以便电脑正常工作或执行特定的功能。CMOS SETUP会将各项数据储存在主板上内见的CMOS SRAM中。当电源关闭时，由主板上的电池继续为CMOS SRAM供电。电源开启后，当BIOS开始进行POST(Power On Self Test开机自检)时，按下“Delete”键便可--AMI BIOS的CMOS SETUP主画面中。主板热启动键“F11” 保存键“F10。

菜单说明: 请注意设置菜单中各项内容，如果菜单项左边有一个三角形的指示符号，表示选择了该项子菜单，将会有一个子菜单弹出来。

1. 主菜单功能

Main	Advanced	Chipset	Boot	Security	Save	Exit
------	----------	---------	------	----------	------	------

- ☆ Main
- ☆ System Overview(系统信息)
设定日期 时间 软硬盘规格及显示器种类
- ☆ Advanced
Advanced Settings(高级BIOS功能设置)
设置BIOS提供的特殊功能，例如病毒警告、开机引导磁盘优先等
- ☆ Chipset
Advanced Chipset Settings(高级芯片组功能设置)
- ☆ Boot
Boot Settings(启动设定)
- ☆ Security
Security Settings(BIOS密码设置)
- ☆ Save
Save Setting(保存设置)
- ☆ Exit
Exit Options(退出设置)
退出设置包括载入优化缺省值/载入故障安全缺省值/放弃更改/不保存
退出

DIRECTORY

Safety Precautions	2
Packing	3
Brief Introduction	4
Motherboard Diagram	5
Rear I/O panel	6
Installation and Settings	7
Drivers Installation	11
BIOS Settings	13

SAFETY PRECAUTIONS

- Products could probably be damaged due to electrostatic discharge(ESD). Please follow these steps below for a successful computer assembly.
- Make sure all parts are firmly connected; otherwise, it might lead to the failure of recognizing components or starting the computer.
- In order to prevent products from being damaged by ESD, please make sure to discharge your body static by touching other metal objects before taking the motherboard out of box.
- Hold the border of motherboard when taking it out. Do not touch the sensitive parts of motherboard.
- Please put the motherboard in an anti-static container or on anti-static pad if not needed.
- Before turning on the computer, make sure all parts inside the case are firmly connected without any loose screws or metal components.
- Do not start the computer before installation finished, otherwise it might result in permanent damage to the computer parts or even injury to the user.
- If you need any assistance in the process of installation, please contact our after-sales customer service or reach us on HUANANZHI official E-mail:business@huananzhi.com for professional technical support.
- Prior to installation or disassembly, please switch off the power and pull the power cable from the socket.

- Keep the motherboard away from moisture.
- Keep the user manual for future reference.
- Before plugging the power supply, please make sure the socket provides the corresponding voltage.
- In any of the following situations, please keep the motherboard and power cable in a safe place. Do not put anything onto the power cable.
- In the event of any of the following conditions, have the board checked by a service technician:
 - Liquid penetrated into the computer.
 - Motherboard is exposed to moisture.
 - Motherboard does not work even if you follow the instructions on user manual.
 - Motherboard fell off to the ground and got damaged.
 - Motherboard has clear signs of damage.

PACKING

- **Please confirm that the motherboard is properly packaged upon purchase of the product. If there is any damage to packaging or lack of accessories, contact us as soon as possible.**
 - 1.HUANANZHI X99-F8D V1.2 DUAL motherboard
 - 2.SATA data cable
 - 3.I/O shield back plat
 - 4.Warranty Card

BRIEF INTRODUCTION

Features

- CPU: Intel® LGA2011-3 Processor Intel® Xeon™
- RAM: 8*DIMM supports up to 256GB DDR4
2400/2133/1866MHZ Non-ECC.ECC memory
Quad-Channel Memory Architecture
Actual memory data rate depends on CPU type and DRAM module
- I/O effects: 6 x SATA 3.0 (maximum transfer speed up to 6GB/s)
4 x SSATA3.0
4 x USB2.0 interface
4 x USB3.0 interface
1 x RTL8125BG Network card interface
- Audio: Realtek Audio Transcoder
Realtek 7.1 Surround Sound High Definition Audio Codec
Audio output:Front Out/Front Speaker Out, Rear Speaker output,
Center/Subwoofer output, Side Horn output
Audio input:Microphone input, Audio input
- Ethernet: 2 x Realtek PCIe Gigabit LAN
- Expansion slot: 3 x PCIe 3.0 x16
2 x M.2 22110 NVME PCIe 3.0X4
1 x M.2 2280 NVME PCIe 2.0 X4@NGFF SSATA3.0

MOTHERBOARD DIAGRAM

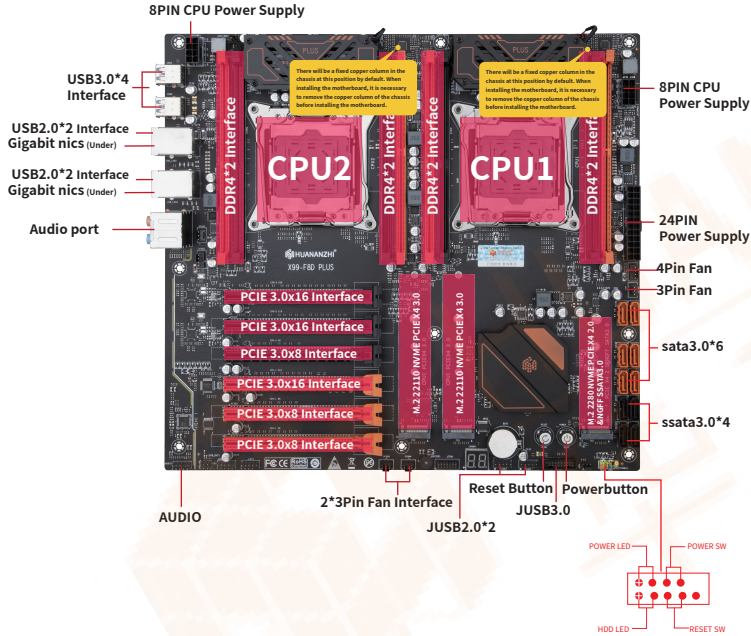

1-1 X99-F8D PLUS V1.2 Motherboard Illustration

Rear I/O Panel

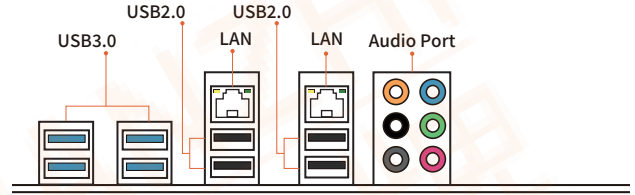

1-2 Overall Rear I/O Panel Display

Connection/Work Light			Speed Signal	
Status	Description		Status	Description
Turn Off	Network Not Connected	Turn Off	Transmission rate 10 Mbps	
Yellow	Network Connected	Green	Transmission rate 100 Mbps	
Flicker	Network In Use	Orange	Transmission rate 1 Gbps	

1-3 LAN Port Status Table

Audio Port	Aisle			
	2	4	6	8
Audio Input				
Audio output/Front speaker output	●	●	●	●
Rear speaker output		●	●	●
Center/subwoofer output			●	●
Microphone input				●
Side speaker output				●

1-4 Audio Port Configuration

Installation And Settings

NOTICE

please check the motherboard where all pins marked with number "1" or white bold line are position "1".

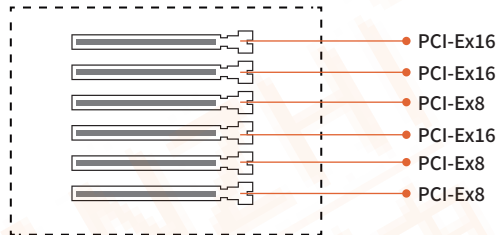

2-4 PCI Expansion Slot

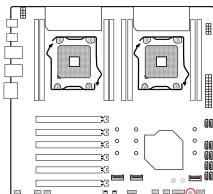

2-1 Clear CMOS Jumper CLR-CMOS

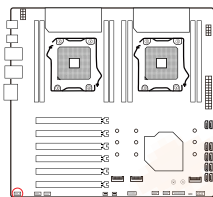
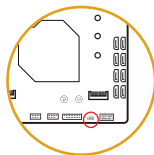

1	MIC+	2	Ground
3	Vbias	4	AuD_Vcc(AVCC)
5	L_R_Out	6	R_Out Back
7	N.C	8	KEY
9	L_L_Out	10	L_Out Back

2-2 Front Audio Output Ports

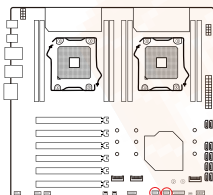

1	VCC	2	VCC
3	D-	4	D-
5	D+	6	D+
7	GND	8	GND
9	N.C	10	KEY

2-5 USB Extension Interface

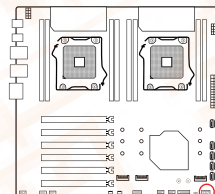

1	PWR LED+	2	HDD LED+
3	PWR LED-	4	HDD LED-
5	PWR_SW	6	RESET_SW
7	PWR_SW	8	RESET_SW
9	KEY	10	N.C

2-5 F_PANEL1 Boot Interface

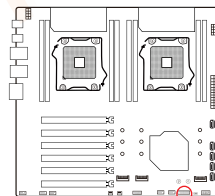

1	Power	2	USB3_RX_DN
3	USB3_RX_DP	4	Ground
5	USB3_TX_C_DN	6	USB3_TX_C_DP
7	Ground	8	USB2.0-
9	USB2.0+	10	GND
11	USB2.0+	12	USB2.0-
13	Ground	14	USB3_TX_C_DP
15	USB3_TX_C_DN	16	Ground
17	USB3_RX_DP	18	USB3_RX_DN
19	Power	20	N.C

2-6 USB3.0 Interface

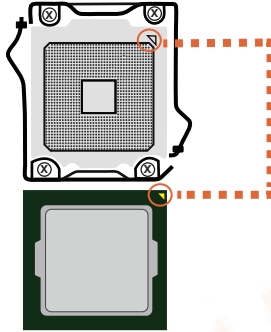
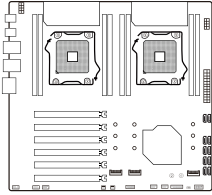

- In order to properly place the CPU in the motherboard, the surface of the LGA2011-3 CPU has two pairs of starting points and a golden triangle. Golden triangle indicates Pin1

2-7 CPU Installation

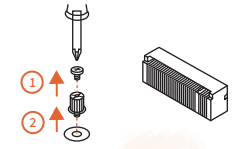

1. Remove the screw from the screw base
2. Remove the screw base

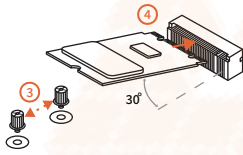

3. Tighten the screw base screwed into the length M.2 module to the M.2 interface distance hole
4. Insert your M.2 module into the M.2 interface at a 30 degree angle

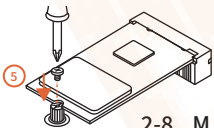

2-8 M.2 Interface Installation

5. Place the screw on the trailing edge notch of your M.2 module and tighten to the screw base

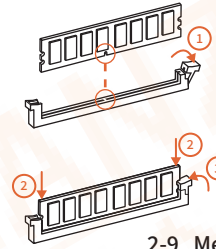

1. Pull the clips on both ends of the memory slot outward, and the memory strip corresponds to the protruding position of the slot to determine the direction of installation.
2. Align the memory module into the slot and press
3. Let the snaps on both ends of the slot automatically bounce

2-9 Memory Installation

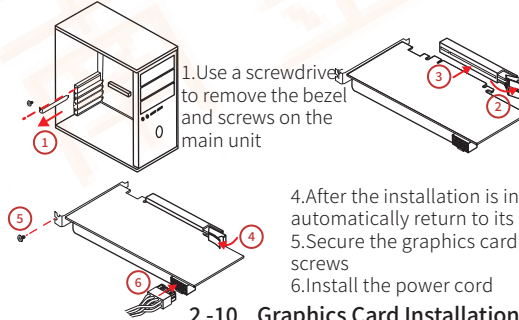

1. Use a screwdriver to remove the bezel and screws on the main unit

2. Need to pick up the card slot of the card slot when installing the graphics card
3. Insert the graphics card into the card slot of the graphics card

4. After the installation is in place, the chuck will automatically return to its position.
5. Secure the graphics card to the chassis with screws
6. Install the power cord

2-10 Graphics Card Installation

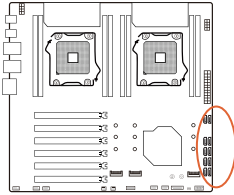

2 -11 SATA Interface Drivers installation

1. Drivers listing:

Driver Directory	Driver Description	Operating System
X99-F8D PLUS Chipset Driver	Intel chip information installation	win7/win10/win11
X99-F8D PLUS Suond Card Driver	Realtek series sound card driver installation	win7/win10/win11
X99-F8D PLUS LAN Driver	Realtek network card driver installation	win7/win10/win11

2. Intel Chip Information Installation

Run "Control Panel - System - Hardware - Device Manager"
Click the right mouse button to change the driver's hardware device and proceed with the installation below:

Option: Property -> Update driver -> Not connect to Internet -> Manually installation
Find the corresponding directory
Select "Next step"

3. Audio driver installation

Before this installation, please check the model of the audio chip on the motherboard first (you may refer to this manual), Select the proper driver accordingly for installation.

3.1 Audio driver installation (take HD Audio series for example)

Run "driver installer": /X99-F8D PLUS SOUND CARD DRIVER /VISTA-WIN7-R267, take WDW-267 if OS is XP

Click on "next" to continue, and then "finished"

The system will automatically restart itself to finish the installation

3.2 Uninstallation of audio driver (take HD Audio series for example)

After logging into Windows desktop, choose "setting"/ "control", and then "add/remove programs". Later, choose "Realtek High Definition Audio Driver" in the menu and click on "add/remove" so that the driver will be automatically removed.

4. Driver installation of external video card

Run "driver installer", take Setup.exe,
Click on "next" - "yes"
-"next"

- "next" and "finished" h

The system will automatically search for devices to complete the installation

5. Driver installation of network

Run "driver installer": X99-F8D LAN DRIVER/WIN7 XP

click on "next"-

"installation"- "finished" and restart the computer,

and restart the computer, The system will automatically search for devices to complete the installation.

BIOS Settings

In order to enable the computer to work well or execute specific functions, CMOS SETUP normally stores all kinds of data in CMOS SRAM of the motherboard. When the computer is shut down, motherboard's battery will supply power to CMOS SRAM. When the computer is turned on and starts POST (Power On Self Test), press "Delete/Del" key to enter into AMI BIOS CMOS SETUP main page. Motherboard warm boot key is "F11", Save the key "F10"

Menu: please pay attention to every option in the settings menu. When there is a triangle shaped symbol on the left side of menu, it means that you choose this sub-menu, so a pop-up sub-menu will be available.

1. Main Menu Function

Main	Advanced	Chipset	Boot	Security	Save	Exit
------	----------	---------	------	----------	------	------

- ☆ Main
 - ☆ System Overview
Date/Time settings, HDD specs/Monitor type settings.
 - ☆ Advanced
Advanced Settings
BIOS special function settings, such as virus alert, booting disk priority etc.
 - ☆ Chipset
Advanced Chipset Settings
 - ☆ Boot
Boot Settings
 - ☆ Security
Security Settings
 - ☆ Save
Save Setting
 - ☆ Exit
Exit Options
- Exit settings include loading of optimized defaults value/ loading of fail-safe defaults / discarding changes/ exiting without saving. Exit settings include loading of optimized defaults value/ loading of fail-safe defaults / discarding changes/ exiting without saving.